

DATOS TECNICOS STRONG 20

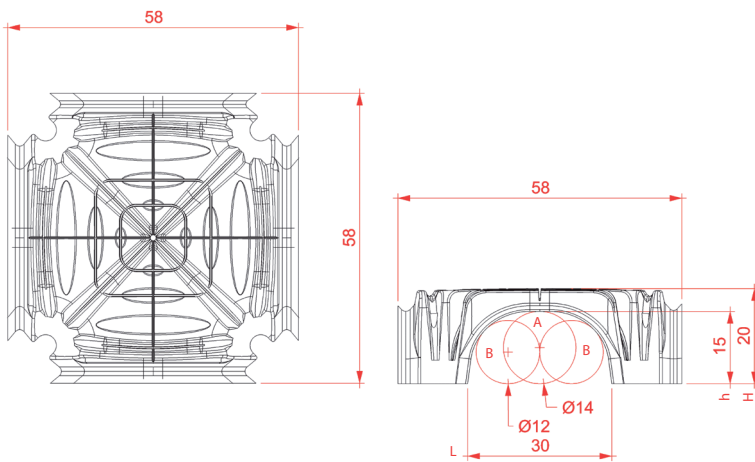

		H20
Dimensiones	cm	58x58
Altura libre h	cm	15
Altura libre L	cm	30
Diam. max tubo A (1 tubo)	cm	14
Diam. max tubos B (2 tubos)	cm	12
Consumo de hormigon	m ³ /m ²	0,029
Mq por palet	m ²	120
Numero piezas por palet	pz	383
Dimensiones pallets		
	A	120
	B	120
	C	235

