

DATOS TECNICOS STRONG 25

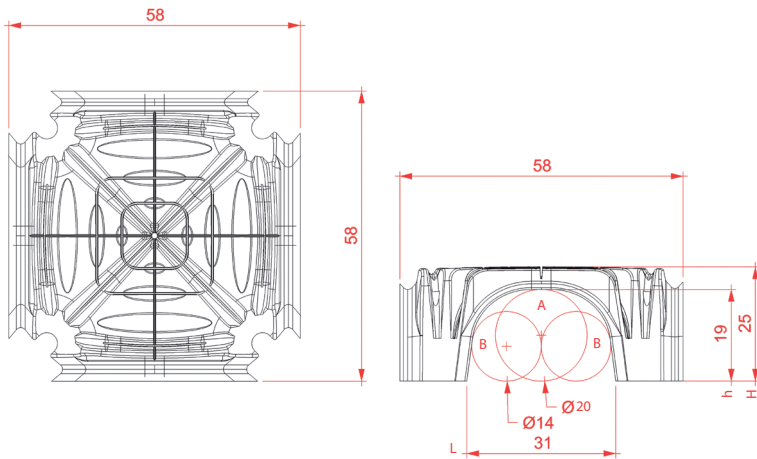

		H25	
Dimensiones	cm	58x58	
Altura libre h	cm	19	
Altura libre L	cm	31	
Diam. max tubo A (1 tubo)	cm	20	
Diam. max tubos B (2 tubos)	cm	14	
Consumo de hormigon	m ³ /m ²	0,040	
Mq por palet	m ²	110	
Numero piezas por palet	pz	351	
Dimensiones pallets		A	120
		B	120
		C	235

