

## DATOS TECNICOS STRONG 30

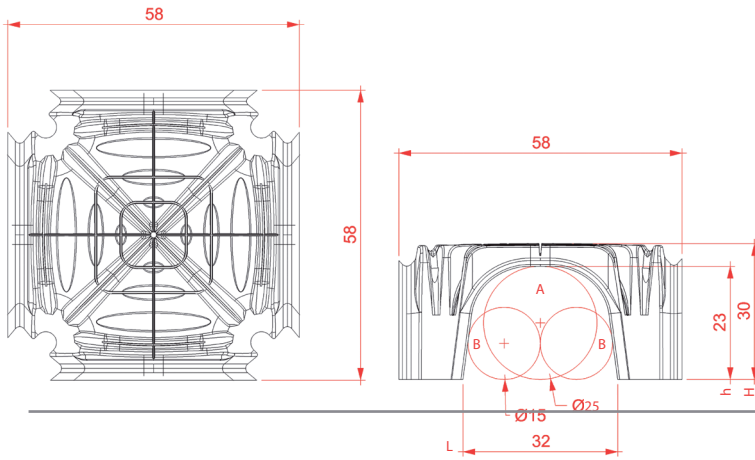

		H30	
Dimensiones	cm	58x58	
Altura libre h	cm	23	
Altura libre L	cm	32	
Diam. max tubo A (1 tubo)	cm	25	
Diam. max tubos B (2 tubos)	cm	15	
Consumo de hormigon	m <sup>3</sup> /m <sup>2</sup>	0,044	
Mq por palet	m <sup>2</sup>	110	
Numero piezas por palet	pz	351	
Dimensiones pallets		A	110
		B	351
		C	235

