

DATOS TECNICOS STRONG 45

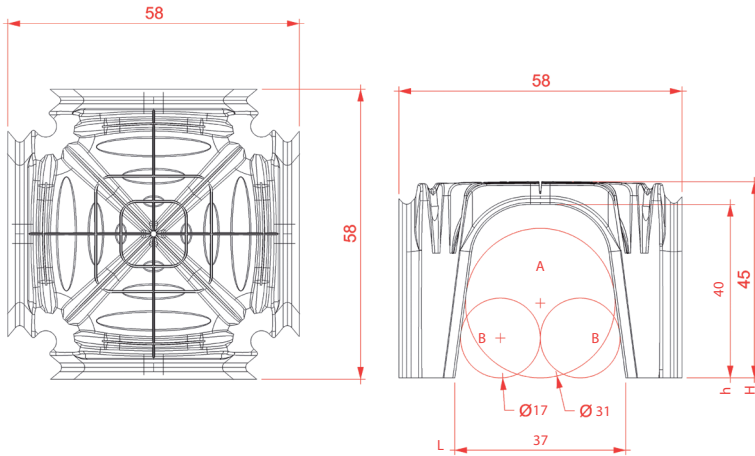

		H45	
Dimensiones	cm	58x58	
Altura libre h	cm	40	
Altura libre L	cm	37	
Diam. max tubo A (1 tubo)	cm	31	
Diam. max tubos B (2 tubos)	cm	17	
Consumo de hormigon	m ³ /m ²	0,066	
Mq por palet	m ²	100	
Numero piezas por palet	pz	319	
Dimensiones pallets		A	120
		B	120
		C	230

