

DATOS TECNICOS STRONG 70

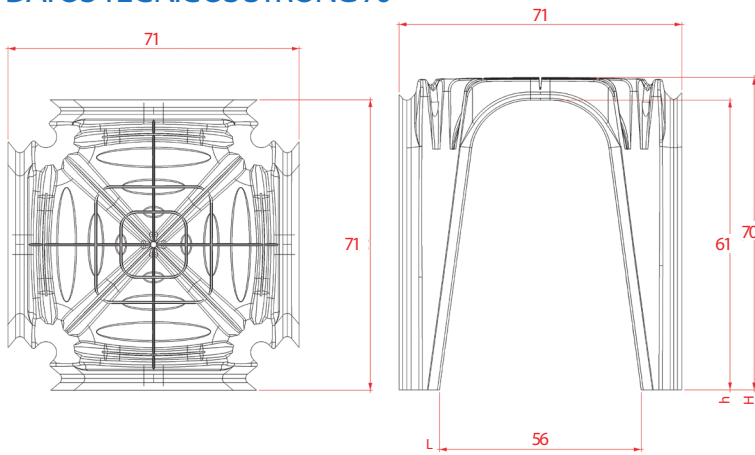

		H70
Dimensiones	cm	71x71
Altura libre h	cm	61
Altura libre h	cm	56
Consumo de hormigon	m ³ /m ²	0,073
Mq por palet	m ²	100/50

